

2

3

1

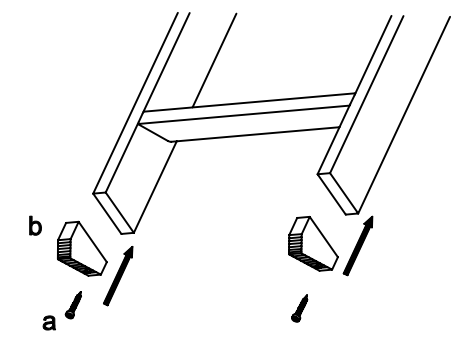
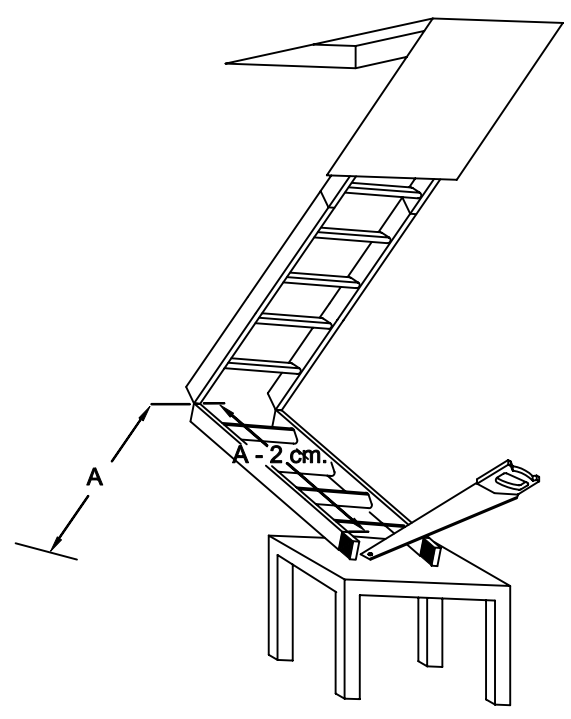
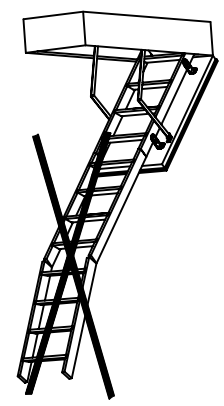

4

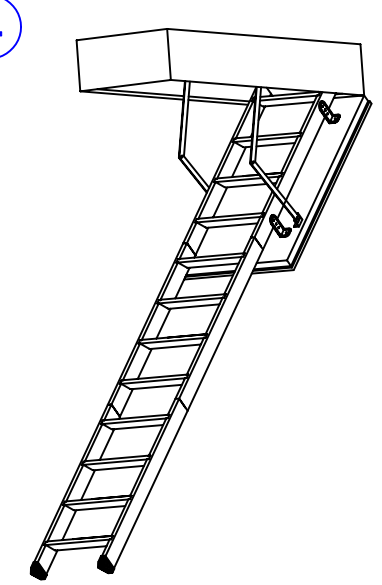

R1 99449 / 251103

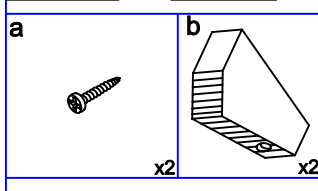

2

3

1

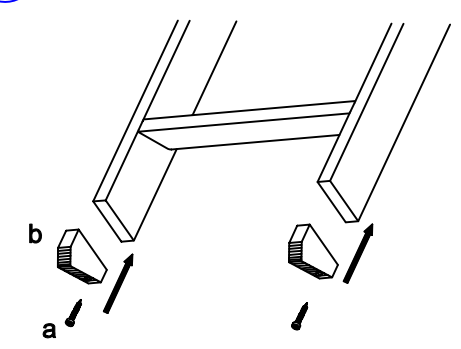
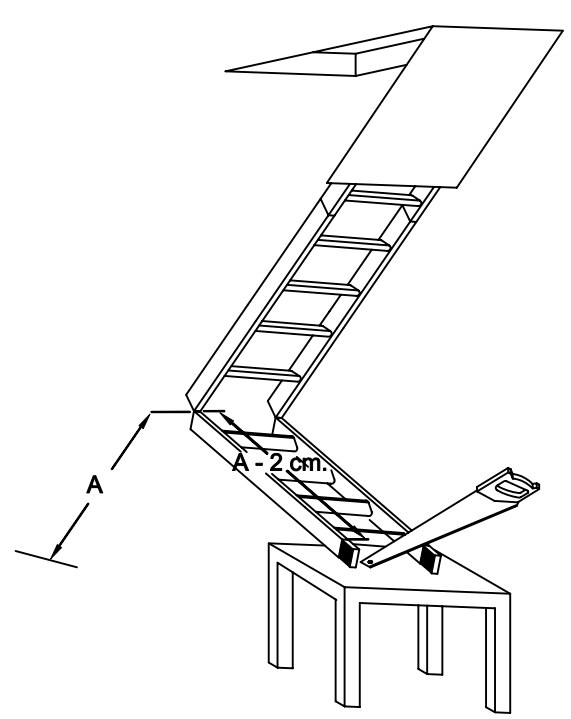
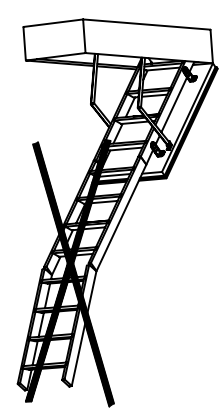

4

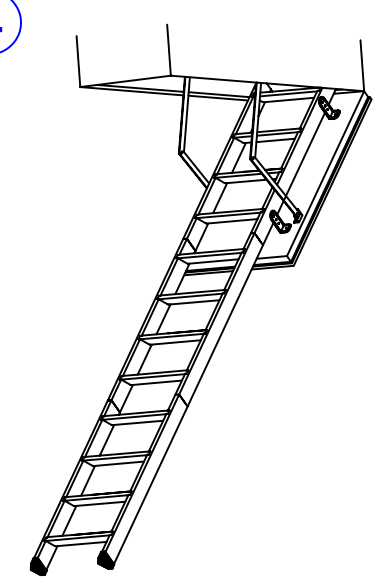

R1 99449 / 251103